

# HAPAX<sup>®</sup>

FOR OUTDOOR APPLICATIONS

DIVISION OF

*pfs*<sup>®</sup>



Quality by  
— europe  
**pgb**



# INDEX

## **Hardwood screws**

*HAWDTG with double thread* 4

## **Hidden fastening system**

*Hapax Fixing Pro* 8

## **Visible fastening system**

*Hapax D-Pro* 10

## **Screw foundation**

*Hapax Rock* 12

## **Adjustable decking support**

*Hapax Atlas* 14

## **Tools**

*Hapax G-Deck* 16

*Hapax Tool* 17

*Hapax drill bit* 18

*Hapax spacers* 18

*Hapax insulation pads* 19

## **Wedging**

*Hapax packer shims* 22

*Hapax hanger shims* 22

*Hapax interlocking wedges* 23

*Hapax high density packers* 23

## **Tips & Tricks**

26

## **Find a Hapax dealer**

31

## **Our references**

32

## **Notes**

34

## HARDWOOD SCREWS WITH DOUBLE THREAD



**T-drive 25:** minimizes the risk of ripping and fully transmits the force into the screw.



The **reduced countersunk head with milling ribs** guarantees a flush finish.

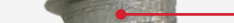

The **double thread** maintains the structure of the boards during dimensional variations. It permanently fixes the boards to the substructure and minimizes cracking.

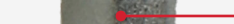

The **milling segment (reamer)** makes the installation of the screw easier and strongly minimizes the risk of ripping.

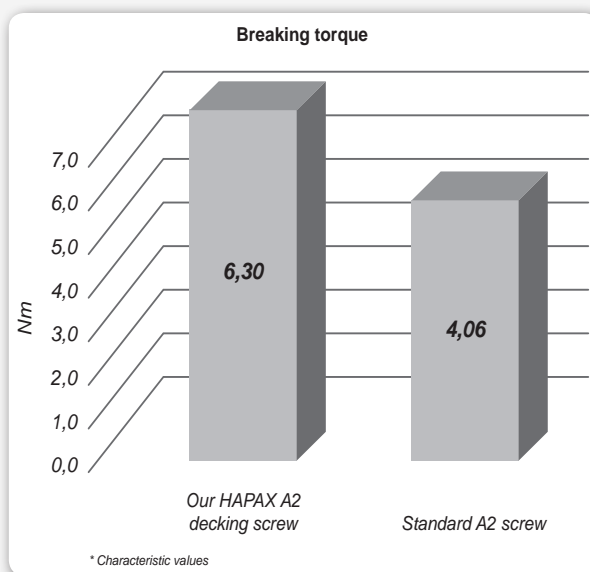

**Special lubricant wax:** improves the penetration of the screw and reduces the screwing-in torque.



The **patented triple thread point** reduces the splitting of the wood drastically, also in delicate applications.

**We recommend screws with diameter  $\geq 5$ mm when fixing hardwood terraces.**



**HARDWOOD SCREWS WITH DOUBLE THREAD, T-DRIVE**

**HAWDTG**

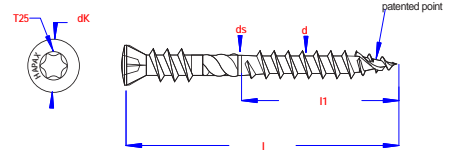

d [mm]	l [mm]	dk [mm]	pgb code	EAN13	TX			
<b>STANDARD PACKING</b>								
<b>5,0</b>	50	8,0	HAWDTGA0000500503	5410439020954	TX 25	200	4800	115200
	60	8,0	HAWDTGA0000500603	5410439020978	TX 25	200	3200	76800
	70	8,0	HAWDTGA0000500703	5410439021012	TX 25	200	3200	76800

**Triple thread point.**

*International patent PCT/IB2016/050652*

**Primary thread**

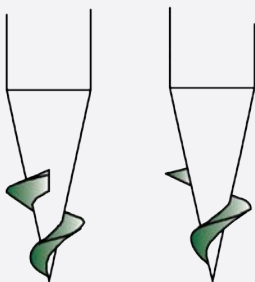

**Milling/drill thread**

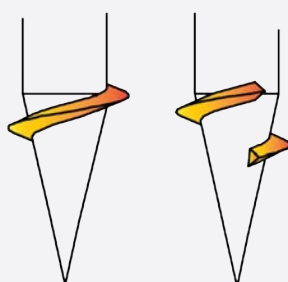

**Starting thread**

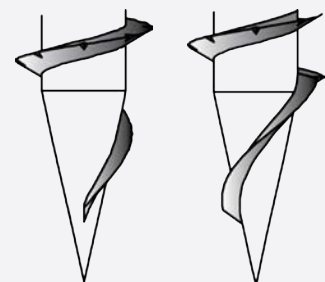



[WWW.HAPAX-EUROPE.COM](http://WWW.HAPAX-EUROPE.COM)



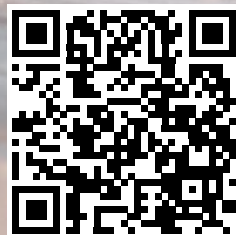

Follow us  
on youtube



# INVISIBLE FIXING

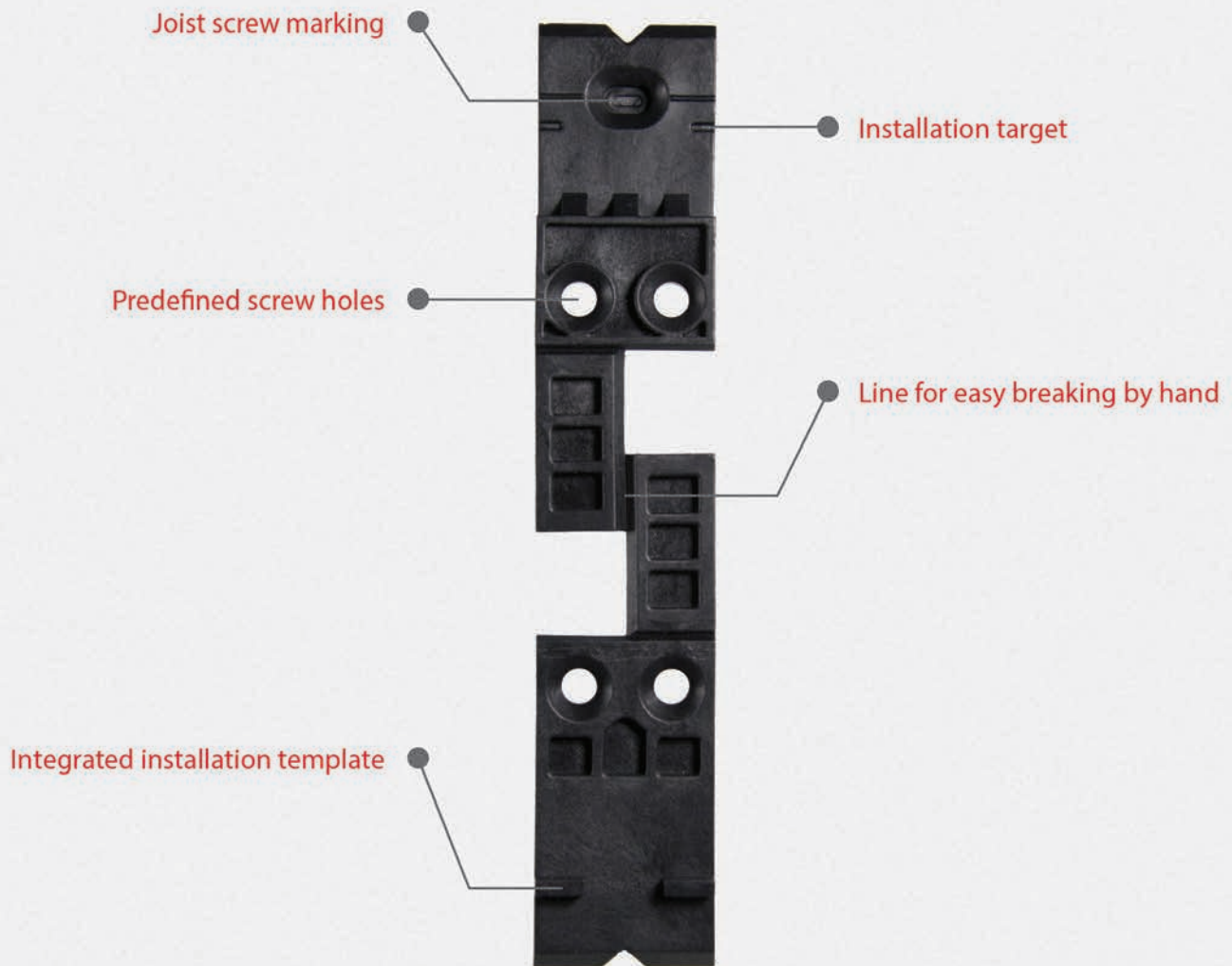



# HAPAX FIXING PRO

## HIDDEN FASTENING SYSTEM



### CHARACTERISTICS

- Totally invisible.
- Rot-proof.
- Weather resistant and pulling endurance of 650kg.
- Very strong hold.
- Adjustable.
- Excellent ventilation.
- Universal: for boards with 90 to 200 mm width and 19 to 40 mm height.
- Material: POM.
- Freeze resistant: -40°C.
- Heat resistant: 110°C.
- Maximal spacing: 50 cm.
- Possible to change 1 board without damaging the rest.

### ADVANTAGES

- Fast.
- UV resistant and resistant to extreme temperatures.
- 100 % recyclable.
- Can be used with any type of joist but also (if required) directly on the tile or concrete (when the available height does not allow the use of a joist).
- Assures an excellent ventilation between the boards and the joists: the use of bituminous strips is not longer necessary.
- 100% invisible: No metal parts or screws are visible. The spacings between the boards are regular. Esthetical and professional result. Moreover, the Hapax Fixing Pro system does not require special parts for the first and last board.
- Easy and quick installation: installed with two stainless steel screws under the boards.
- No profile is necessary.

### USABLE WITH

Can be used with the following types of wood: Ipe, African Padauk, Bamboo, Ash, Poplar and Oak, Accoya, kiln dried Cumaru, kiln dried Tali, kiln dried Afrormosia, Afzélia, kiln dried Bankirai, kiln dried Iroko, Merbau, Moabi, Sapelli, Sipo, kiln dried Tatajuba, Teak, Canadian Western Red Cedar.

### STAINLESS STEEL C2 (AISI 410)



- Not suitable for woods containing high amounts of tanning agents.
- Not acid resistant and not suitable for use in chlorous environments.
- Screws made of AISI 410 are hardened and polished. Due to its natural properties this martensitic stainless steel is (slightly) magnetised.

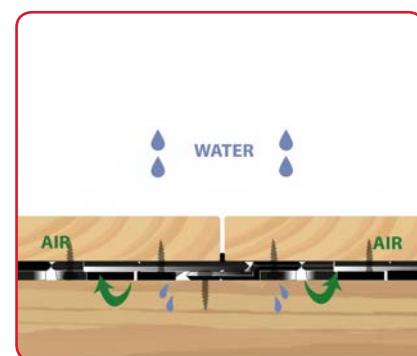
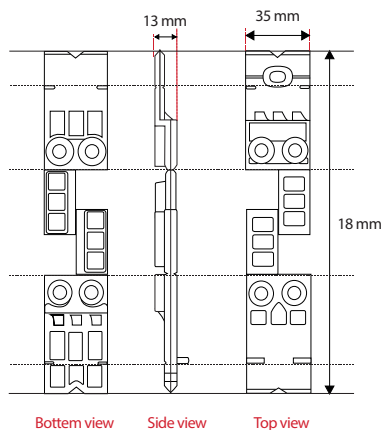

Manual

140 mm	1 set = 6 m <sup>2</sup>
120 mm	1 set = 5 m <sup>2</sup>
90 mm	1 set = 4 m <sup>2</sup>



d x l [mm]	d x w x l [mm]	pgb code	EAN13		
5,5 x 30 5,5 x 35	35 x 13 x 180	HAP010C00FIXPRO3	5410439473682	100 x Fixing 200 x 5,5 x 30 mm 100 x 5,5 x 35 mm	88 boxes
5,5 x 30 5,5 x 35	35 x 13 x 180	HAP010B00FIXPRO3	5410439475983	100 x Fixing 200 x 5,5 x 30 mm 100 x 5,5 x 35 mm	88 boxes
5,5 x 35	35 x 13 x 180	HAP011C00FIXPRO3	5410439473699	100 x Fixing 300 x 5,5 x 35 mm	88 boxes

For boards with a height of 19-27 mm

For boards with a height of 19-27 mm

For boards with a height of 28-40 mm

# VISIBLE FIXING

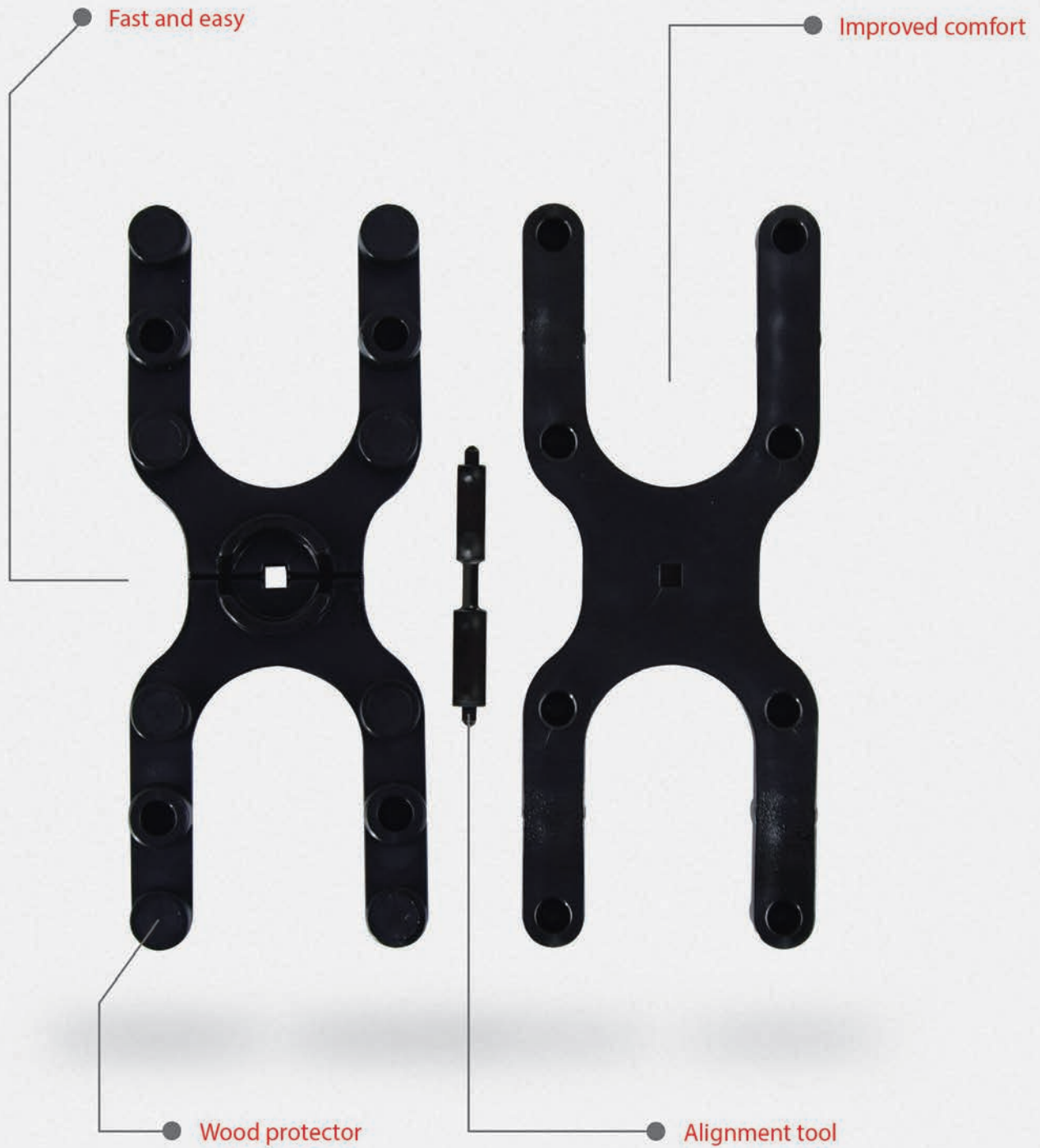

# HAPAX D-PRO

## VISIBLE FASTENING SYSTEM



### CHARACTERISTICS

- Eliminate thermal bridges.
- Alternative for bitumen strip.
- Removable shims.
- Material: recycled composit.
- Freeze resistant: -40°C.
- Heat resistant: 110°C.

### ADVANTAGES

- UV resistant and resistant to extreme temperatures.
- Significantly reduces the risk of deformation of the boards and shearing of the screws.
- Creates excellent ventilation between the boards and joists to improve the stability of the wooden deck.
- Removes water traps between the wooden boards and the joists reduces the risk of rotting.
- Spacers integrated and removable. Allows regular spacing of 4, 5, 6 or 7 mm between the boards of your wooden deck.
- Improves the comfort of the deck thanks to its shock absorbing characteristics.
- 100 % recyclable.

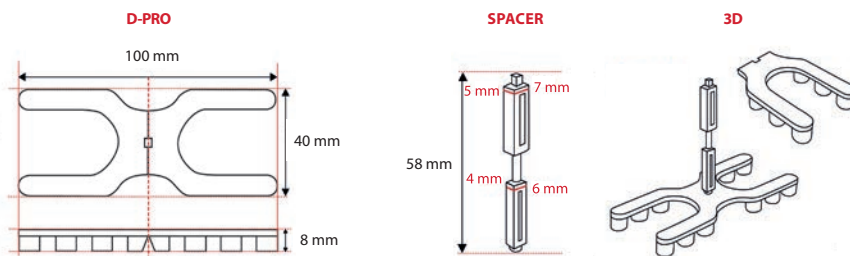
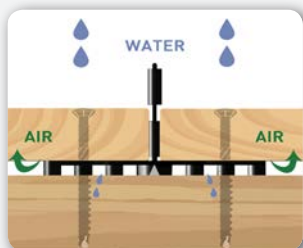

140 mm	1 set = 6m <sup>2</sup>
120 mm	1 set = 5m <sup>2</sup>
90 mm	1 set = 4m <sup>2</sup>

Manual



d x l [mm]	D-PRO [mm]	pgb code	EAN13		
5 x 60	8 x 100 x 40	HAP020A00DPRO3	5410439473736	100 x D-PRO 20 x 4 x 5 x 6 x 7 mm 200 x 5 x 60 mm	192 boxes
5 x 60	8 x 100 x 40	HAP020B00DPRO3	5410439479271	100 x D-PRO 20 x 4 x 5 x 6 x 7 mm 200 x 5 x 60 mm	192 boxes
5 x 70	8 x 100 x 40	HAP021A00DPRO3	5410439473743	100 x D-PRO 20 x 4 x 5 x 6 x 7 mm 200 x 5 x 70 mm	192 boxes
5 x 70	8 x 100 x 40	HAP021B00DPRO3	5410439479288	100 x D-PRO 20 x 4 x 5 x 6 x 7 mm 200 x 5 x 70 mm	192 boxes

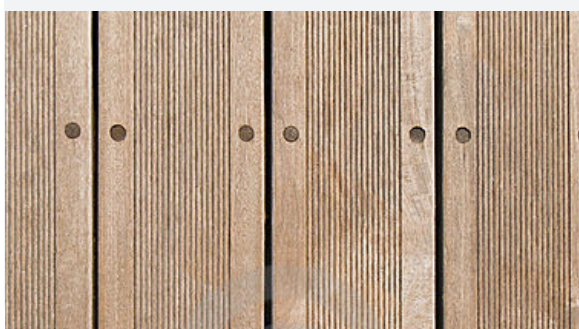



# HAPAX ROCK

SCREW FOUNDATION





# HAPAX ROCK

## SCREW FOUNDATION





### CHARACTERISTICS

- Replaces the concrete foundations.
- Permanent adjustment within a range of 35-250 mm
- Beam support.
- Extension: additionally up to 160 mm more height.
- Up to 5 lengths can be installed to 1 Hapax Rock for a total height of 112 cm.
- Head diameter: 123 mm for joist of 120x200 mm.
- Material: polypropylene.
- Freeze resistant: -50°C.
- Heat resistant: 90°C.
- Maximum weight per Hapax Rock: 800 kg.

### EXTENSION | 16 CM

HAP040N00ROCKEXT1



d [mm]	l [mm]	EAN13		
140	260	5410439473835	1	252 boxes

### E-DRIVER

HAP041N00EDRIVER1

FOR RENT



 5 min / Rock

Nm	EAN13		
2000	5410439473828	1	1 box

### SCREW AID

HAP041N00TDRIVER1



EAN13		
5410439473811	1	1 box

### ADVANTAGES

- Weather-resistant.
- Completely removable and recyclable.
- Ecological: leaves no trace in the environment.
- Easy and fast installation.
- Simple installation by drilling a hole at a certain place in the ground using a manual or electric screw driver. It only takes 5 minutes.
- Adjustable in height from 35-250 mm.
- The head has an integrated adjustable lever, for easy leveling.

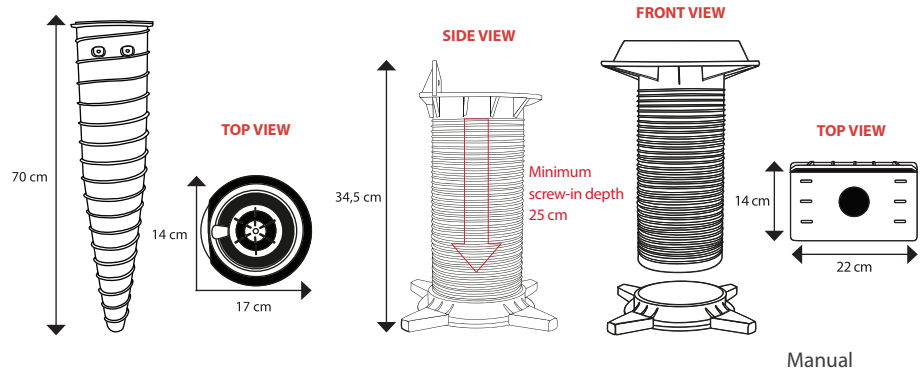

d [mm]	l [mm]	pgb code	EAN13	
140	700	HAP040N00ROCK1	5410439473842	50 boxes

### CALCULATION - DOUBLE CONSTRUCTION

Quick calculation for the number of supports:  $m^2 \times 0,6$

#### BEAMS FROM EXOTIC WOOD

Minimum section: 45\*70 mm

Distance between the beams: 1,20 m

Distance between the supports: 1,50 m

#### BEAMS FROM CONIFEROUS OR DECIDUOUS TREES

Minimum section: 63\*150 mm

Distance between the beams: 1,50 m

Distance between the supports: 2 m

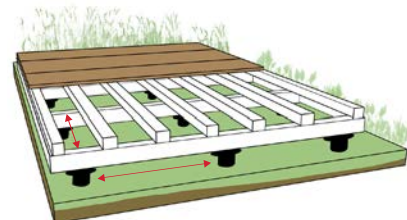

# HAPAX ATLAS

ADJUSTABLE DECKING SUPPORT

Support plate



Extension



Adjustable decking support

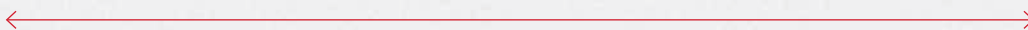

Ø 21,5 cm

# HAPAX ATLAS

## ADJUSTABLE DECKING SUPPORT





### CHARACTERISTICS

- Adjustable from 3 cm to 100 cm.
- Material: recycled PP composite.
- UV resistant
- Resistant to extreme temperature fluctuations
- Dismountable
- Reusable
- Maximum weight per atlas: 800 kg
- Freeze resistant: -25°C
- Heat resistant: 70°C

### SUPPORT PLATE FOR WOOD

HAP042ATLASPLW1





d [mm]	EAN13		
122	5410439606608	250 (5x50)	4000

### SUPPORT PLATE FOR TILES

HAP042ATLASPLT1





d [mm]	EAN13		
122	5410439607063	250 (5x50)	4000

### EXTENSION | 35 MM

HAP042ATLASEXT1



*\*Use only with a 50-90 mm adjustable decking support.*

h [mm]	EAN13		
35	5410439607025	250 (5x50)	3500

### ADVANTAGES

- Suitable for tiles in concrete, ceramics and natural stone as well as wooden decks.
- Because of the space they create under the deck they ensure a smooth drainage.
- The joints between the floor elements are open so that water can seep through and there is no risk of cracking.
- Significantly reduces the installation time when controlling the height of the terrace.
- Completely replaceable and reusable.
- Strong and accurate.
- 100% environmentally friendly.
- Easy and fast installation.
- Extends the life of the deck.



FOR WOOD



30-50mm  
\*Not extendable



50-90mm  
excl. steunplaat  
\*Extendable

h min [mm]	h max [mm]	pgb code	EAN13		
30	50	HAP042ATLAS03051	5410439606523	50	1000
50	90	HAP042ATLAS05091	5410439606561	50	700

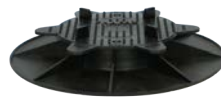

FOR TILES



30-50mm  
\*Not extendable



50-90mm  
excl. steunplaat  
\*Extendable

h min [mm]	h max [mm]	pgb code	EAN13		
30	50	HAP042ATLAS0305T1	5410439013307	50	1000
50	90	HAP042ATLAS05091	5410439606561	50	700

**IT IS RECOMMENDED TO LEAVE A MINIMUM OF 40 CM AND A MAXIMUM OF 60 CM BETWEEN THE TERRACE SUPPORTS.**



# G-DECK

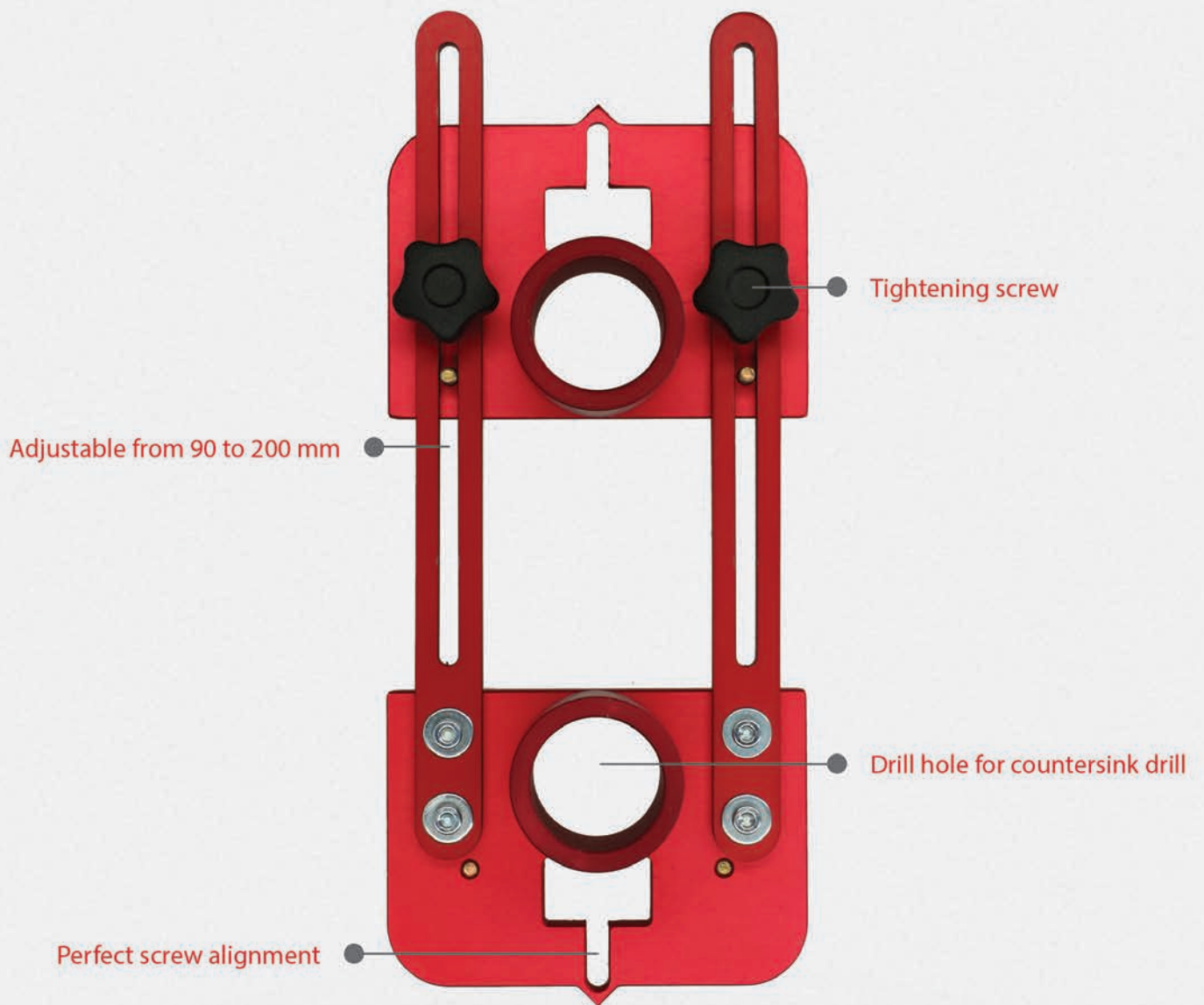



## HAPAX G-DECK

### TEMPLATE FOR MOUNTING DECK SCREW



#### CHARACTERISTICS

- Material: anodised industrial aluminium.
- Width: 80 mm.
- Overall length (open): 200 mm.
- Thickness: 6 mm.
- Adjustable: 90 à 200 mm.

#### ADVANTAGES

- Template for a fast and easy installation.
- Essential construction tool.
- Very precise alignment of the screws.
- Esthetical and professional result.

#### REFERENCE

pgb code	EAN13	
HAP030GDECK1	5410439473774	1



## HAPAX TOOL

### DECKING BOARD WRENCH



#### CHARACTERISTICS

- Dismountable and reversible.
- Material: anodised industrial aluminium.
- Weight: 1550 g.
- Powerful: 20kg of pressures on the handle results in a force of 85 kg.
- Maximal force: 180 kg.

#### REFERENCE

pgb code	EAN13	
HAP030CLAMP1	5410439473750	1

#### HAPAX TOOL PIN | Ø10X70 | 3 PCS



## HAPAX DRILL BIT WITH STOP FUNCTION



### CHARACTERISTICS

- HSS M2 steel drill bit for hardwood drilling.
- HSS M2 steel cutter.
- Wings for collecting wood shavings.
- Allen key screw for replacing drill bits.
- Adjustment shim for milling depth.
- Drilling depth: max 30 mm (regulated).
- Cutter diameter:  
ø4: 12mm | ø5: 12mm | ø6: 15mm
- Milling depth: adjustment in the range of 4 to 16 mm.

### INCLUDED

- 1 x drill
- 1 x socket key

### REFERENCES

pgb code	EAN13	
HAP031DRILL0401	5410439473781	1
HAP031DRILL0501	5410439473798	1
HAP031DRILL0601	5410439473804	1

### SPARE DRILL



ø4: HAP031SPARE0401    ø5: HAP031SPARE0501  
ø6: HAP031SPARE0601

## HAPAX SPACER | 4/5/6/7 MM FOR 4 JOINT WIDTHS

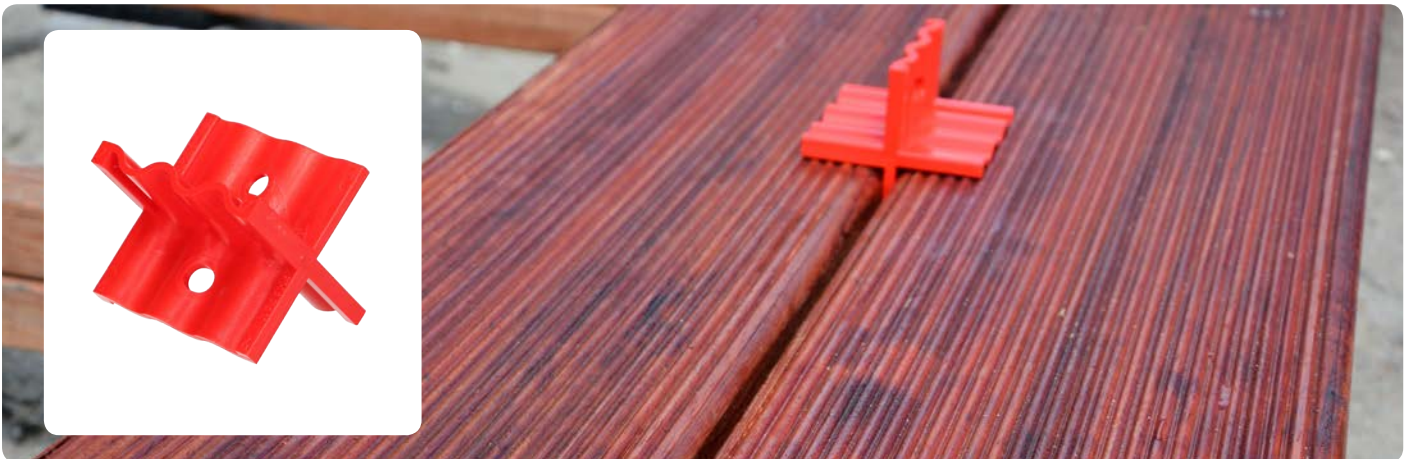

### CHARACTERISTICS

- Spacer : 4-5-6-7mm
- The wavy design prevents getting stuck between the boards.
- The spacings between the boards are regular.
- Consider the requirements of your timber supplier to determine the appropriate joint width.

### INCLUDED

- 3 x spacers

### REFERENCE

pgb code	EAN13	
HAP034N000001A	5410439476768	3

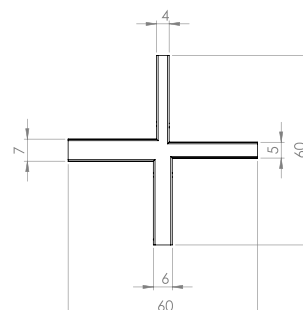



## HAPAX EPDM INSULATION PAD

100 x 100 x 8 MM

EPDM



### CHARACTERISTICS

- Product will not rot.
- Increases the stability and lifetime of the deckings' substructure.
- Ventilation and insulation of the substructure: no direct contact with the soil.
- Decreases noises of the wood and increases the comfort.
- For flat surfaces.

### REFERENCES

pgb code	EAN13	
HAP032PAD5	5410439482424	24

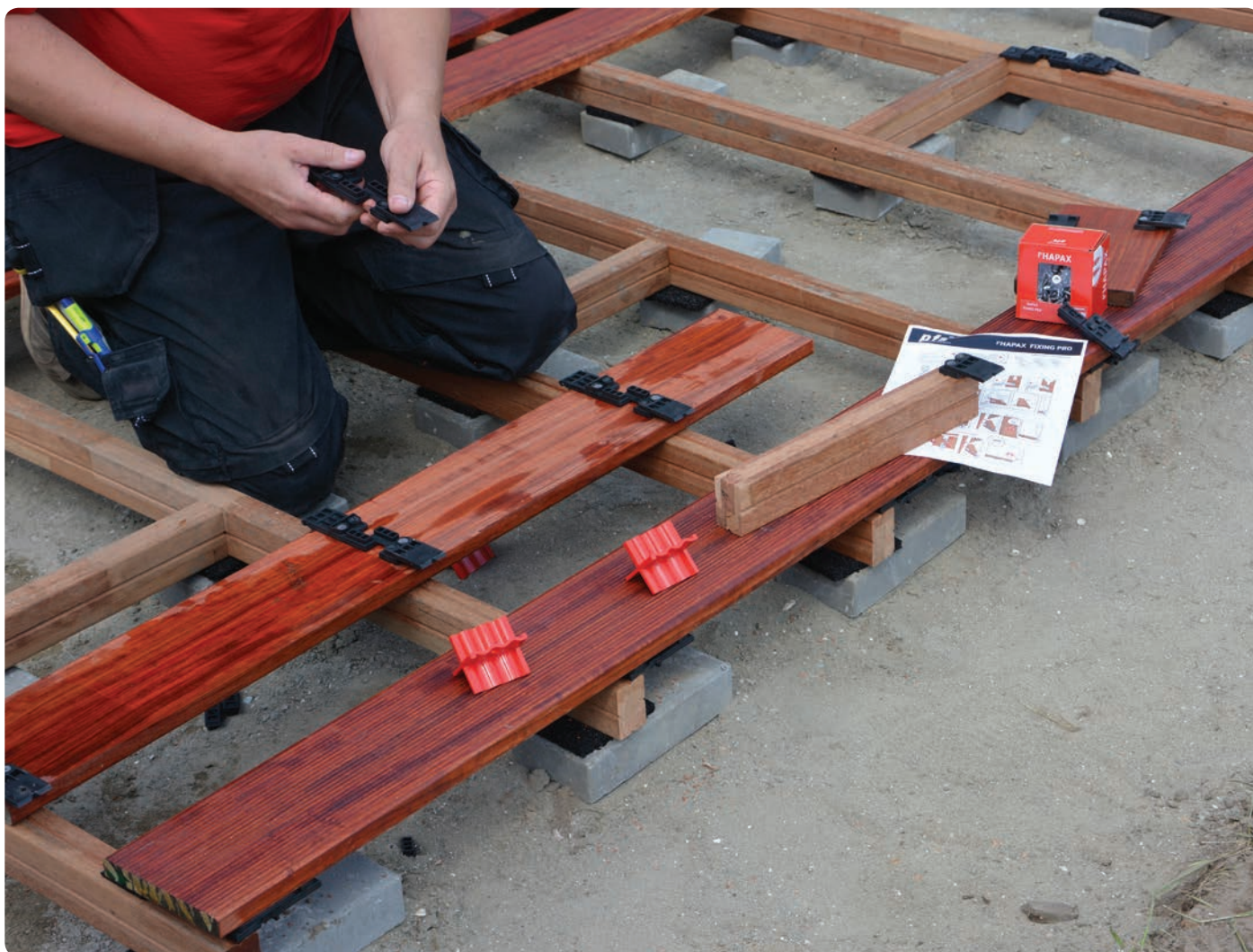



# HAPAX WEDGES





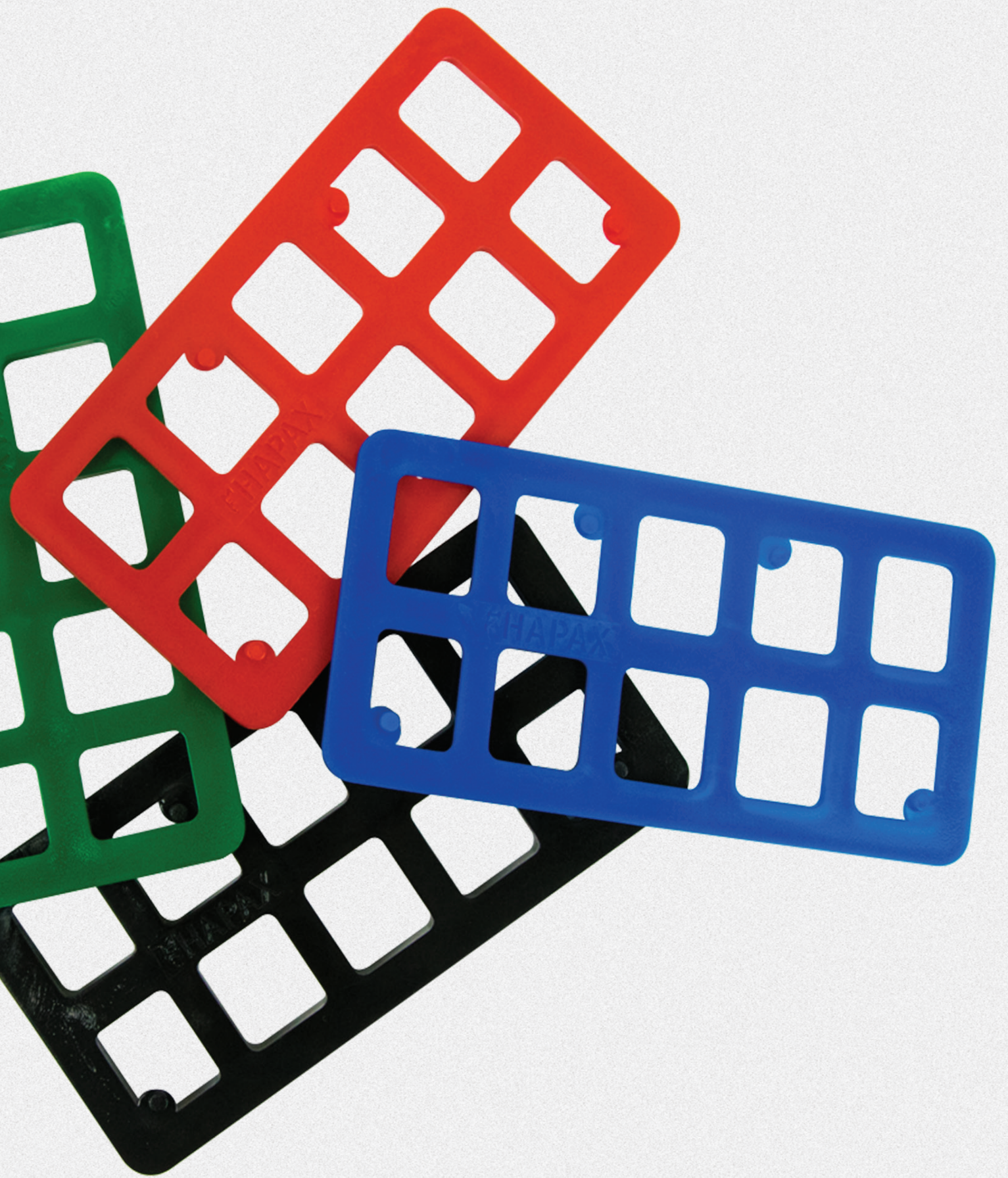









## HAPAX PACKER SHIMS

FOR WEDGING AND LEVELLING AT A LOW HEIGHT

 300 kg









h [mm]	w [mm]	l [mm]	pgb code	EAN13	Colour		
1	22	95	HAP050N00001000955	5410439473859		1000	72
2	22	95	HAP050N00002000955	5410439473866		1000	72
3	22	95	HAP050N00003000955	5410439473873		1000	72
4	22	95	HAP050N00004000955	5410439473880		1000	72
5	22	95	HAP050N00005000955	5410439473897		1000	72
1 - 5	22	95	HAP051N00SET01M	5410439473903	mixed	40 x 1 mm 40 x 2 mm 40 x 3 mm 40 x 4 mm 40 x 5 mm	189
1 - 5	22	95	HAP051N00SET02M	5410439473910	mixed	100 x 1 mm 100 x 2 mm 100 x 3 mm 100 x 4 mm 100 x 5 mm	112

## HAPAX HANGER SHIMS

FOR WEDGING AND LEVELLING DURING VERTICAL CONSTRUCTION WORKS

 300 kg







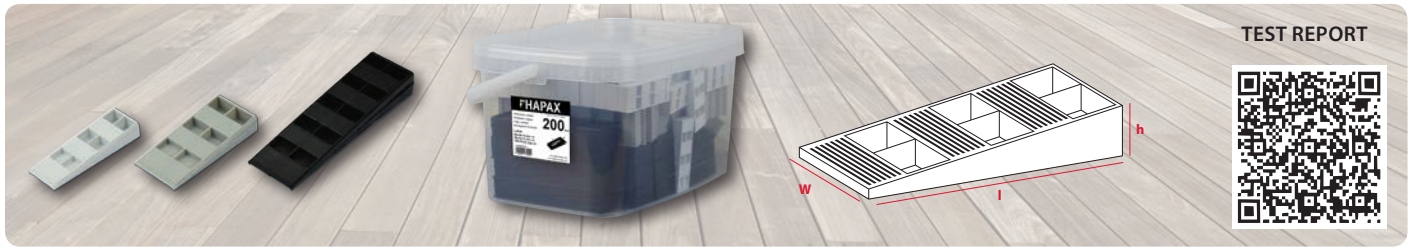

h [mm]	w [mm]	l [mm]	pgb code	EAN13	Colour		
1	40	55	HAP052N00001000555	5410439473927		1000	72
2	40	55	HAP052N00002000555	5410439473934		1000	72
3	40	55	HAP052N00003000555	5410439473941		1000	48
4	40	55	HAP052N00004000555	5410439473958		1000	48
5	40	55	HAP052N00005000555	5410439473965		1000	40
1 - 5	40	55	HAP052N00SET01M	5410439473972	mixed	40 x 1 mm 40 x 2 mm 40 x 3 mm 40 x 4 mm 40 x 5 mm	189
1 - 5	40	55	HAP052N00SET02M	5410439473989	mixed	100 x 1 mm 100 x 2 mm 100 x 3 mm 100 x 4 mm 100 x 5 mm	50

## HAPAX INTERLOCKING WEDGES

FOR WOODEN SURFACES

 600 kg









h [mm]	w [mm]	l [mm]	pgb code	EAN13	Colour		
14	30	90	HAP053N00030000905	5410439476225		200	72
15	43	95	HAP053N00043000955	5410439476232		200	48
22	43	150	HAP053N00043001505	5410439476249		100	48
14 - 22	30 - 43	90-150	HAP053N00SET01M	5410439473996	mixed	50 pcs : 14 x 30 x 90 mm 30 pcs : 15 x 43 x 95 mm 10 pcs : 22 x 43 x 150 mm	112
14 - 22	30 - 43	90-150	HAP053N00SET02M	5410439474009	mixed	90 pcs : 14 x 30 x 90 mm 60 pcs : 15 x 43 x 95 mm 50 pcs : 22 x 43 x 150 mm	50

## HAPAX HIGH DENSITY PACKERS

FOR WEDGING AND LEVELLING HEAVY LOADS

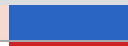
 2000 kg



h [mm]	w [mm]	l [mm]	pgb code	EAN13	Colour		
2	50	100	HAP054N00002001005	5410439474016		500	72
3	50	100	HAP054N00003001005	5410439474023		500	72
5	50	100	HAP054N00004000505	5410439474047		500	48
10	50	100	HAP054N00010001005	5410439474054		250	48
2 - 10	50	100	HAP054N00SET01M	5410439474061	mixed	100 pcs : 2 x 50 x 100 mm 40 pcs : 3 x 50 x 100 mm 40 pcs : 5 x 50 x 100 mm 20 pcs : 10 x 50 x 100 mm	112









# DIY PACKAGING

## HAPAX PACKER SHIMS







FOR WEDGING AND LEVELLING AT A LOW HEIGHT

 300 kg



h [mm]	w [mm]	l [mm]	pgb code	EAN13	Colour		
1	22	95	HAP051N0000100095A	5410439480574		20	100
2	22	95	HAP051N0000200095A	5410439480598		20	100
3	22	95	HAP051N0000300095A	5410439480611		20	100
4	22	95	HAP051N0000400095A	5410439480635		20	100
5	22	95	HAP051N0000500095A	5410439480659		20	100
1 - 5	22	95	HAP051N0000600095A	5410439481496	gemixt	10 x 1 mm 10 x 2 mm 10 x 3 mm 10 x 4 mm 10 x 5 mm	250









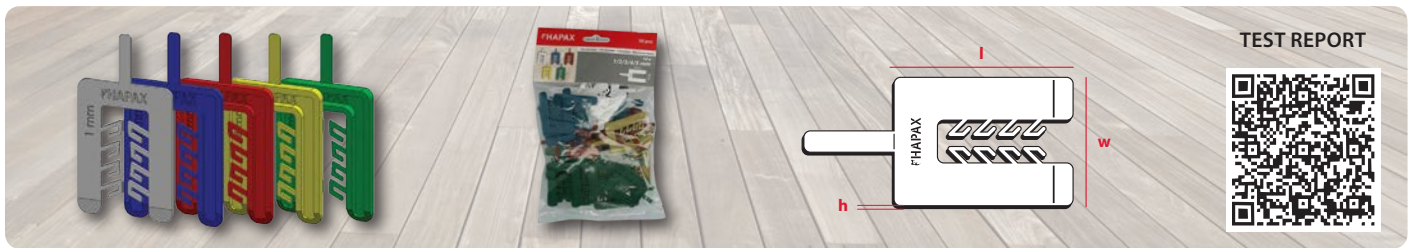

d [mm]	w [mm]	l [mm]	pgb code	EAN13	Colour	
1	22	95	HAP051N00010000955	5410439480871		100
2	22	95	HAP051N00020000955	5410439480888		100
3	22	95	HAP051N00030000955	5410439480895		100
4	22	95	HAP051N00040000955	5410439480901		100
5	22	95	HAP051N00050000955	5410439480918		100

## HAPAX HANGER SHIMS

FOR WEDGING AND LEVELLING DURING VERTICAL CONSTRUCTION WORKS

 300 kg



h [mm]	w [mm]	l [mm]	pgb code	EAN13	Colour		
1	40	55	HAP052N0000100055A	5410439480673		20	100
2	40	55	HAP052N0000200055A	5410439480697		20	100
3	40	55	HAP052N0000300055A	5410439480710		20	100
4	40	55	HAP052N0000400055A	5410439480734		20	100
5	40	55	HAP052N0000500055A	5410439480758		20	100
1 - 5	40	55	HAP052N0000600055A	5410439481526	gemixt	10 x 1 mm 10 x 2 mm 10 x 3 mm 10 x 4 mm 10 x 5 mm	250







## HAPAX INTERLOCKING WEDGES

FOR WOODEN SURFACES

 600 kg



h [mm]	w [mm]	l [mm]	pgb code	EAN13	Colour		
14	30	90	HAP053N0000100055A	5410439480772		8	40
15	43	95	HAP053N0000200055A	5410439480796		6	30
22	43	150	HAP053N0000300055A	5410439480819		4	20





# The checklist

How to construct a wooden deck ?

© Wooden deck placed with Hapax

## INSTALLATION RECOMMENDATIONS

### A quality wooden deck

**W**ood, a noble and living material, is often exposed to intense stress when used during the installation process of a terrace : bad weather conditions, differences in humidity and temperature, moisture from underneath, UV, mechanical stress, ...

Achieving an outdoor terrace of quality, which is stable and lasts for a minimum of 20 years, requires great rigor in the design and choice of materials. Quality is a key issue to satisfy customers as well as it gives back the nobility that a wooden deck deserves.

When placing a wooden deck, your choices about materials and implementation techniques will have a strong influence on two aspects :

**Sustainability :** A wooden deck can be degraded more or less quickly (between 5 and 30 years) under the effect of various biological circumstances (insects, moisture), depending on the quality of the materials, ventilation and compliance with the correct method of implementation.

**Stability :** Wood is subjected to weather, it swells and shrinks significantly, which can lead to deformation such as warp, uplift, cupping and bending, ... of the wooden decks.

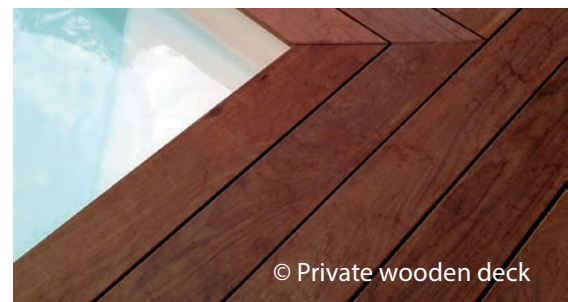

© Private wooden deck



# THE WOOD

## Choose the decking

### Respect the width-thickness ratio of the wooden deck

The width of the deck should be a maximum of 7 times its thickness. For example :  $21 * 7 = 147$  mm maximum width. In case of non-compliance with this rule, the higher the risk of deformation of the decks.

### Choose your decks carefully

Be careful when you choose your decks. Make sure the decks are not bent or cupped or show irregular patterns in the wood fibre.

Remember to check whether the thickness of your decks is in line with the thickness proposed by your wood supplier.

### Check the dryness of the deck

Some species of wood have more grains than others : Cumaru, Yellow Balau, Massaranduba, ... . It is necessary that these wood species are KD dried (Kiln Dried). On average, the dryness of the decks should be around 16 %. Check the dryness with your timber dealer and require the information to be stated on the invoice (in case of dispute, you will be protected). If necessary, you can use a moisture meter to check the dryness of your decks.

## Choose the wood structure

### Service class

The service class structure of the wood is mandatory or greater than that of the decking. It is easier to replace a deck board than a complete structure. It is better to focus more on the quality of the wood than the deck structure.

### Ventilation

Never put the wood structure in direct contact with the ground to avoid premature rotting of the wood. Always use shims or polymer pads to isolate the joists on the ground. It is important to have some space between the deck and the substructure, by using a thermal bridge such as Hapax D-Pro or the invisible Hapax Fixing.

### Set the distance between the joists

It is better to reduce the distance between the joists, because it will reduce the risk of deformation of the deck boards.

### The joists

The minimum height and width of the joists has to be 40 x 60 mm.



# DESIGN

## General rules

### Never place the wood in direct contact with the ground

The space between the decking and the ground allows the terrace to be well ventilated, which improves the stability and the life span of the terrace. Always use shims or polymer pads to isolate the joists on the ground. The distance between the decks is about 4 and 6 mm for a terrace that is about 10 cm high.

### Create or maintain a drainage slope for rainwater

Make sure to provide a slope of 0,5 to 1 cm per meter.

### Always create a decking frame

The decking frame is made of several joists, placed at a certain distance from each other, forming a rectangular structure. This structure offers more strength and stability to the wooden deck.

### Double the joists

Always double the joists. It will offer better support to the wooden deck and lower the risk of water damage.

## A terrace on soft ground

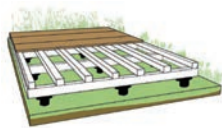

### Use a geotextile

Start placing your geotextile on the ground to prevent the regrowth of plants through the terrace.

### Use a fixed batten on the wall

When the terrace has to be attached to the house, you can use a fixed batten. This batten will function as a general reference for the entire terrace and it will serve as one of the primary support joists.

### Use an environmental friendly construction

Use the Hapax Rock screw foundations instead of a concrete foundation for your terrace. The soil will remain intact and the resistance of the screw foundation is similar to the concrete one.

## A roof terrace



### Use shims or Hapax Atlas decking supports

Never perforate the waterproof membrane of the roof to avoid the risk of water infiltrating the building. Use shims or adjustable polymer pads to isolate the joists on the waterproof membrane. The shims or pads make sure the membrane is not perforated and still allows drainage of the rainwater.

## A terrace on hard ground

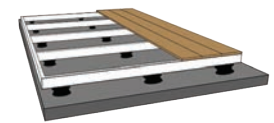

### Use shims or Hapax Atlas decking supports

When installing a terrace, it is necessary to use shims or adjustable polymer pads to isolate the joists on the floor.

### Fixing the structure to the floor

In most cases you will drill holes in the floor to attach the joists using concrete screws or hammer nail plugs.



Hapax Rock screw foundation

# INSTALLATION

## General rules

### The space between the deck boards

The spacing between the deck boards depends on the moisture content in the decks and the height of the deck. The average spacing is 4 to 6 mm for a terrace height of 10 cm.

### Alignment

It is essential to treat the alignment of the first deck boards row. For this we will use a masonry cord. Check the alignment every 7 boards.

### Use a thermal bridge

It is essential to use a thermal bridge between the decks and the joists to avoid moisture stagnation. For example : Hapax D-Pro, Hapax Fixing, ...

## Fixing with screws



### Choice of screws

It is mandatory to use special terrace screws to ensure a good performance of the screw in the decks. It is important to calculate the length of the screw : minimum 2 x the thickness of the deck. It is better to choose a longer screw than one that is too short. We recommend screws with diameter  $\geq 5$ mm when fixing hardwood terraces.

### Screwing instructions

The screw must be placed at least 2,5 cm from the edge of the decking boards.

### Finishing

For a perfect finish, we recommend pre-drilling the decking boards. This pre-drilling is imperative for hardwood screws with a density of 850 kg/m<sup>3</sup>. Also keep in mind the alignment of the screws. At this time, the Hapax G-Deck tool will come in handy.

## Hidden fastener

### Screw placement

Follow the instructions of the installation scheme.

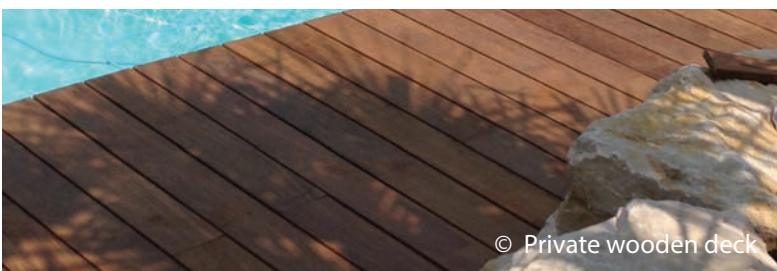



# FINISHING

## General rules

### Alignment between the deck boards

The decks should be aligned perfectly. They will have the same width and regular spacing.

### The use of finishing decks

The finishing decks are used to hide the structure that hold the actual terrace. However, always make sure there is enough space for ventilation to protect the terrace from moisture. This finish gives the terrace a really professional look.

### Sanding

The final sanding with 80 grit will eliminate any wood surface defects, such as oil stains, your pencil marks and splinters caused by sawing the decks.

## Maintenance

### Remove moss and debris

Once a year, during the spring, you will have to apply maintenance to your wooden deck. Use a brush to wipe of all the moss and debris. Once you have done that, use your pressure cleaner to remove the remaining dirt and stains.

### Preserve the natural colour of the deck

Over time, the beauty of a natural wood deck can lose its lustre as the UV (ultraviolet) rays from the sun break down the wood's structure. If the deck has taken on a dull grey look, the problem may be easier to fix than it looks. You can clean your wooden deck with soap and water or bleach, or any other commercial powder or liquid concentrates on the market. This should solve the problem. After cleaning the deck, you can apply a finish that contains UV blockers and a pigment to keep the UV rays from turning the deck grey again.



# FIND A HAPAX DEALER

On our website, you can quickly and easily find a dealer in your area.

- 1 Scan the QR code to go directly to the page on our website.
- 2 Enter your zip code and/or city.
- 3 Choose the radius of your search and click on "Search".







*Private garden*  
SAINT-TROPEZ (FR)



*Célestins Beach*  
VICHY (FR)

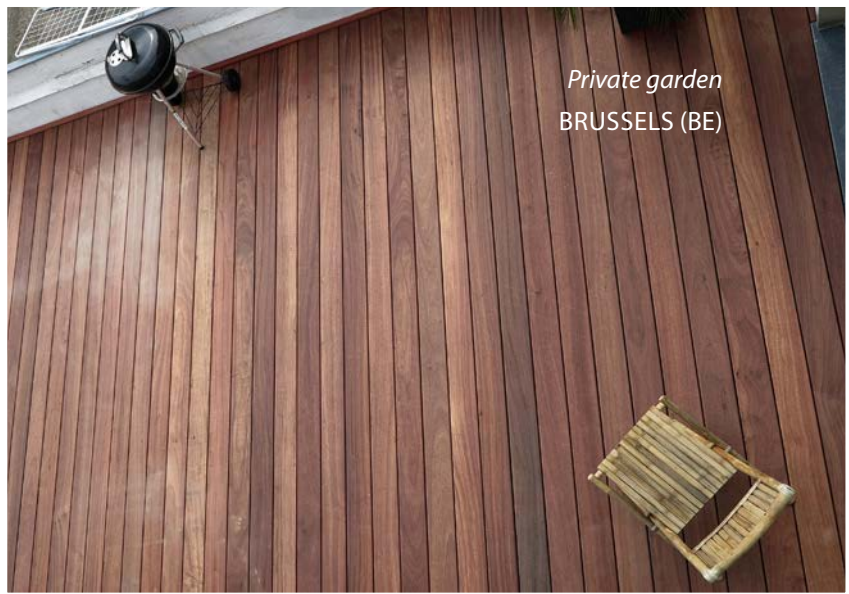

*Private garden*  
BRUSSELS (BE)



*Private garden*  
GENVAL (BE)



*Thalasso*  
DINARD (FR)





*Thalasso*  
DINARD (FR)



*Private garden*  
BRUSSELS (BE)

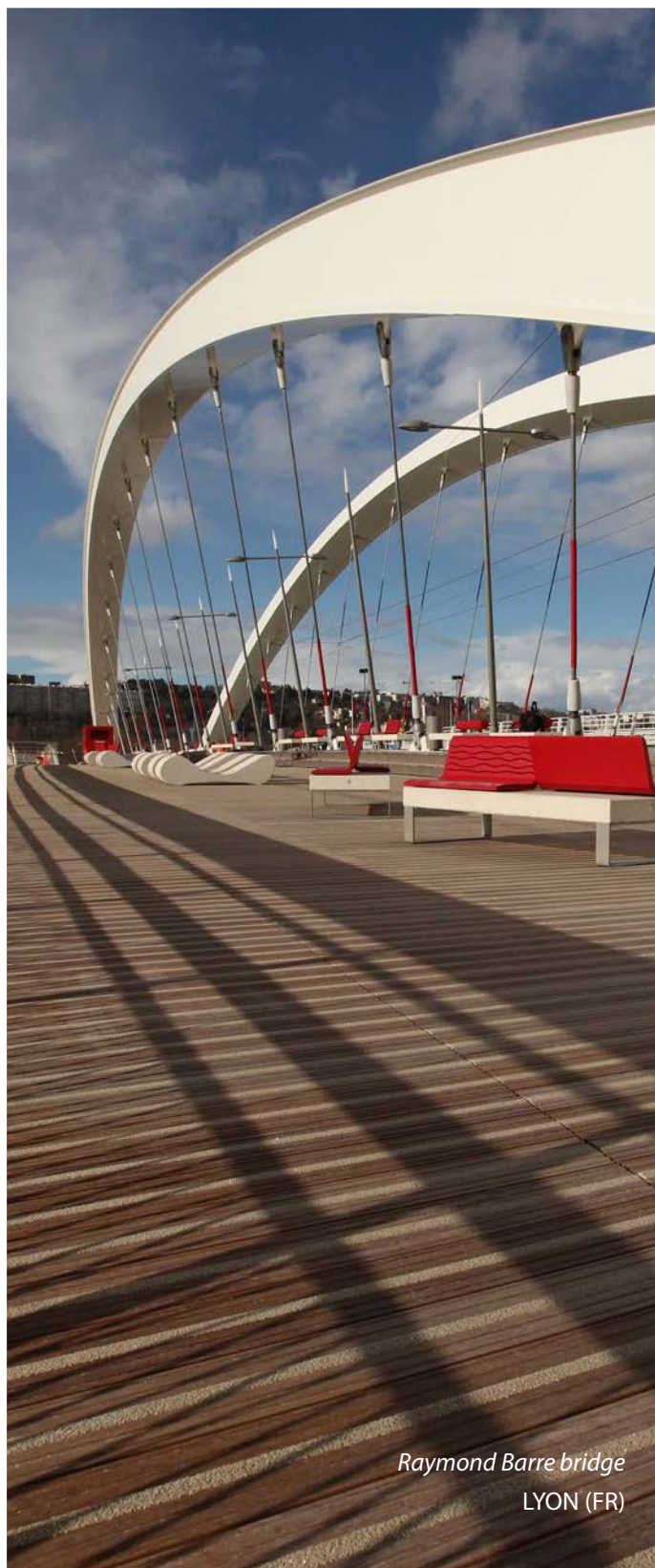

*Raymond Barre bridge*  
LYON (FR)



*PAPETEE*  
TAIHITI (DOM-TOM)



*Private garden*  
RIXENSART (BE)

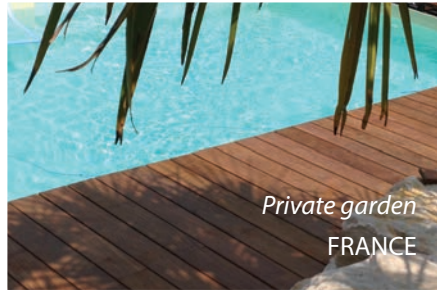

*Private garden*  
FRANCE



*Célestins Beach*  
VICHY (FR)



*Private garden*  
BRUSSELS (BE)



*Private garden*  
FRANCE



*Private garden*  
FRANCE

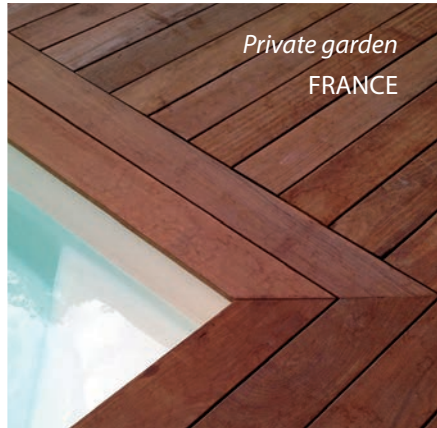

*Private garden*  
FRANCE







[WWW.HAPAX-EUROPE.COM](http://WWW.HAPAX-EUROPE.COM)





**pgb-Europe**  
Logistics centre

Gontrode Heirweg 170  
9090 Melle  
Belgium  
T: +32 9 272 70 70  
F: +32 9 272 70 99  
info@pgb-europe.com

[www.pgb-europe.com](http://www.pgb-europe.com)

**pgb-Polska**  
Production plant

Ul. Fryderyka Wilhelma Redena 3  
41 - 807 Zabrze  
Poland  
T: +48 (32) 330 26 10  
F: +48 (32) 330 26 20  
biuro@pgb-polska.com

[www.pgb-polska.com](http://www.pgb-polska.com)

**pgb-France**  
Sales office

25 Rue du Champ des Oiseaux  
59230 Saint-Amand-les-Eaux  
France  
T: +33 (0)3 27 21 56 80  
F: +33 (0)3 27 30 31 16  
info@pgb-france.com

[www.pgb-france.com](http://www.pgb-france.com)